

# DOUBLE BODIED HYDRAULIC VALVES

- ✓ Allows a greater flow range than a single chamber valve of the same size.
- ✓ **THREE TYPES OF DIAPHRAGMS:** Three models of diaphragms and springs depending on the necessities. PN16 irrigation high pressure, PN06 standard pressure and PN04 irrigation low pressure (valve opens with 4mca).
- ✓ **ACCESS AND MAINTENANCE:** It allows an easy access to the inner part of the valve only manipulating the screws between covers and bodies.
- ✓ **POSITION:** Horizontal or vertical position of the valve, does not affect the operation or hydraulic specifications of the product.
- ✓ **ONLY SUITABLE FOR AGRICULTURAL USE**

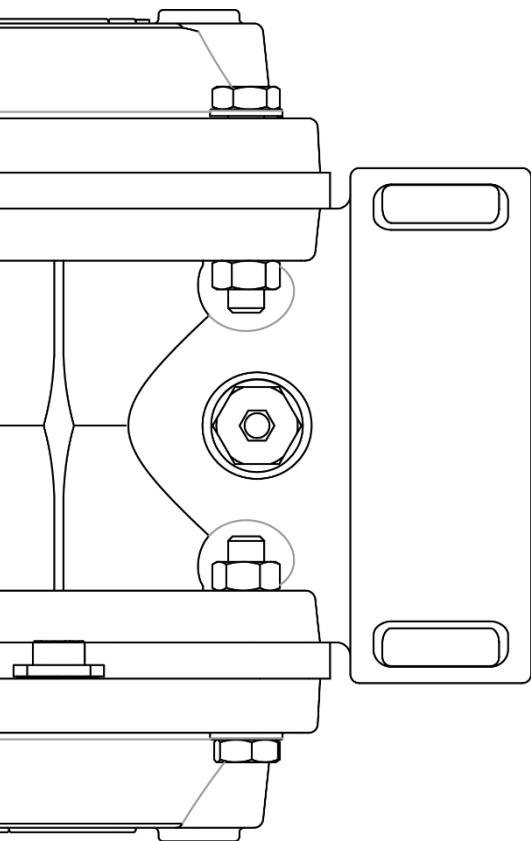
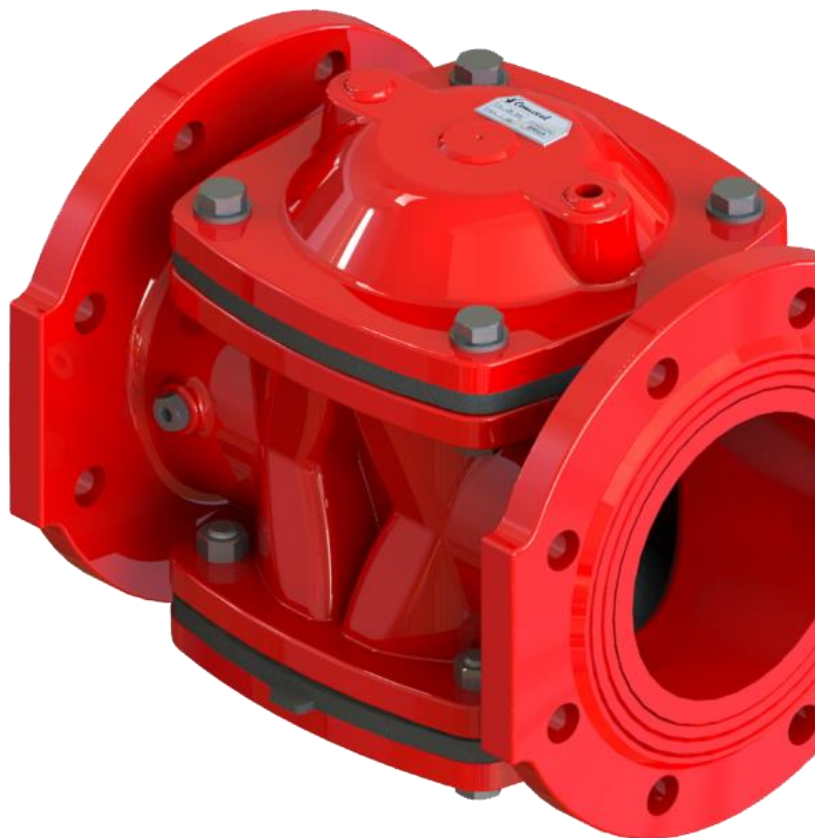

## SPECIFICATIONS

- **CONNECTIONS:** Flanges ISO-7005-2 (ANSI or BS under request)  
Female BSP thread (NPT under request)
- **DESIGN:** Double bodied line valve.
- **SIZES RANGE:**  
Threaded: 2"-3"  
Flanged: DN125 -DN150
- **NOMINAL PRESSURE (bar):** PN04, PN06 or PN16.  
(psi): PN58, PN87 or PN232.
- **MINIMUM ACTIVATION PRESSURE:**  
PN04: 0,4 bar  
PN06: 1,0 bar  
PN16: 1,5 bar

## MATERIALS

- **BODY AND COVER:** GG Cast Iron.
- **DIAPHRAGM:** Natural rubber reinforced with nylon.
- **SPRING:** Stainless steel.
- **COVERING:** Epoxy-polyester double covering.

COMETAL hydraulic valves comply with the specifications of the standards **UNE - EN 1074** about valves for the supply of water and **ISO 9635** about irrigation valves with reference to **general requirements, mechanical resistance and watertightness**.

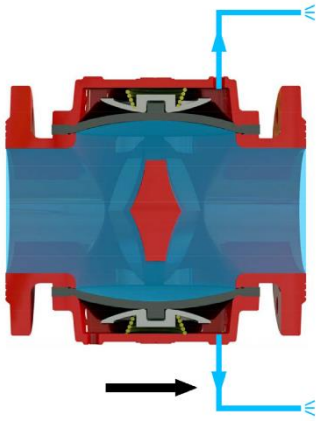

When pressure upstream is the minimum activation one, both chambers are completely open. The load loss is minimal.

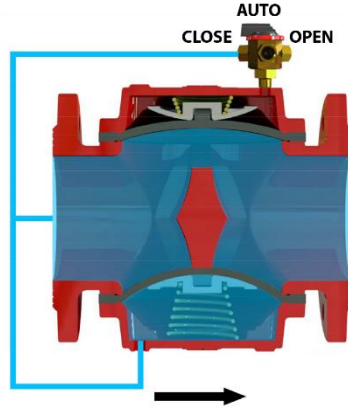

This design has the possibility of working with a chamber always closed, being able to work with two different flow rates.

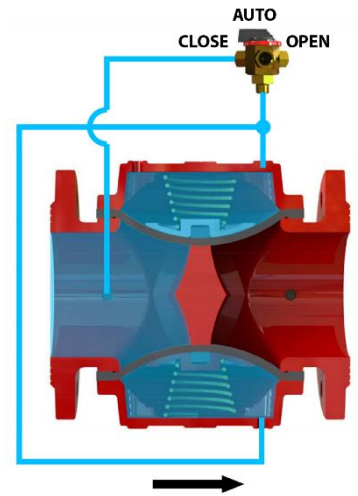

Linking the two chambers, it works like a valve of simple chamber. In this case the openings and closures should be included in two stages.

DIMENSIONS AND WEIGHTS

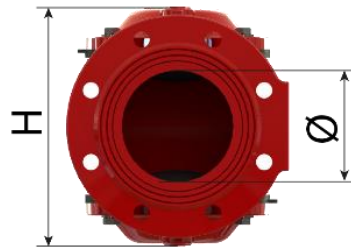
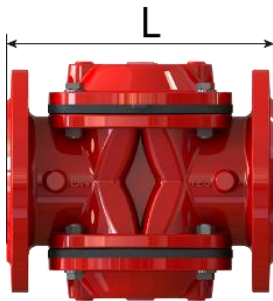

MODEL	CONNECTION	LENGTH (L)		HEIGHT (H)		INSIDE DIAM (Ø)	WIDTH (W)		WEIGHT Kg
		mm	inch	mm	inch		mm	inch	
2"	ROSCA	187	7.36	145	5.71	2"	125	4.92	6,02
3" (323)	ROSCA	210	8.27	175	6.88	3"	125	4.92	8,28
DN125	BRIDA	300	11.81	275	10.83	5"	250	9.84	34,1
DN250	BRIDA	496	19.53	540	21.26	10"	380	14.96	150,3

THREAD VALVES



COMETAL valves comply with the following standards for threaded connections:  
 BSP. 7.1 ISO - 228.1 ISO - UNE - EN 10226 - BS-EN 10226. ISO standard and European standards.  
 NPT. ASME-ANSI B 1.20. American standard.

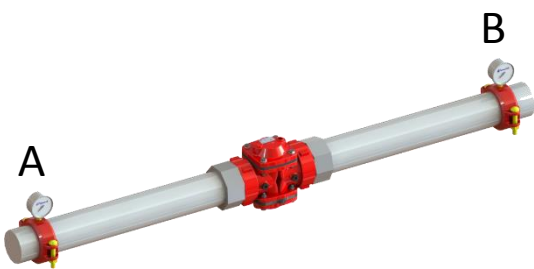
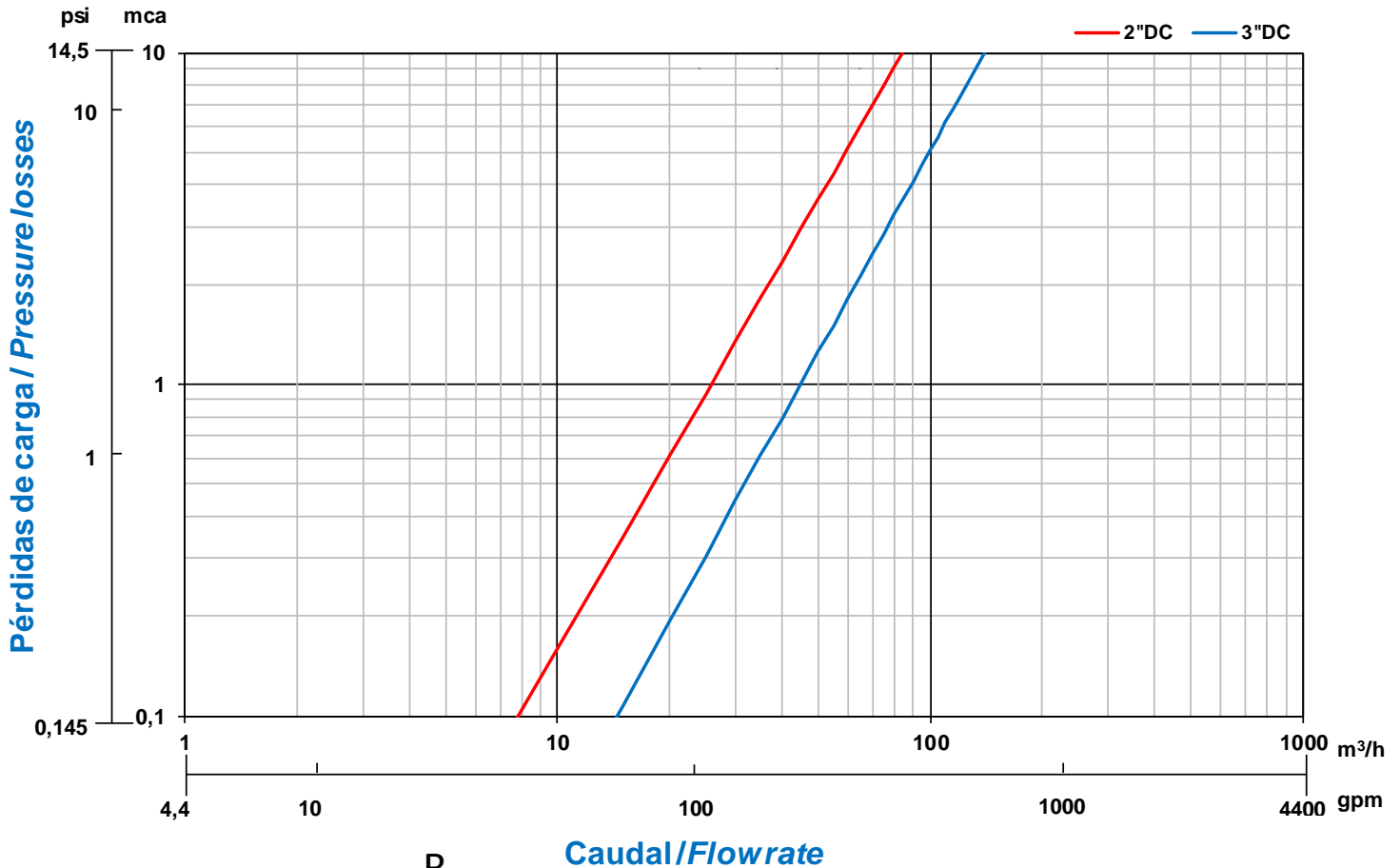

Friction Head Loss is measured from A to B

COMETAL hydraulic valves comply with the specifications of the standards UNE-EN 1267 and ISO 9644 in terms of friction head loss tests.

MODEL	CONNECTION	KV		CONTROL CHAMBER VOLUME
		m3/h	gpm	litres
2"	THREAD	85	374	0,29
3"	THREAD	140	616	0,34

FLANGED VALVES



COMETAL valves comply with the following standards for flanged:  
 ISO 7005 - DIN - UNE-EN 1092-BS-EN 1092. ISO standard and European standards.  
 ASME-ANSI B 16.1 - 16.5 B. American standard.  
 AS 2129. Australian standard.

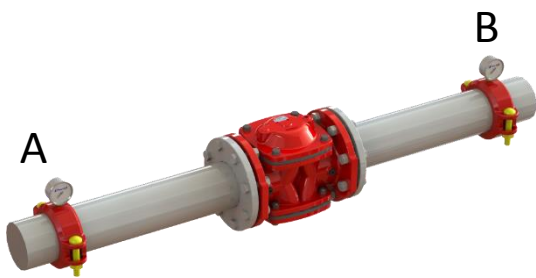
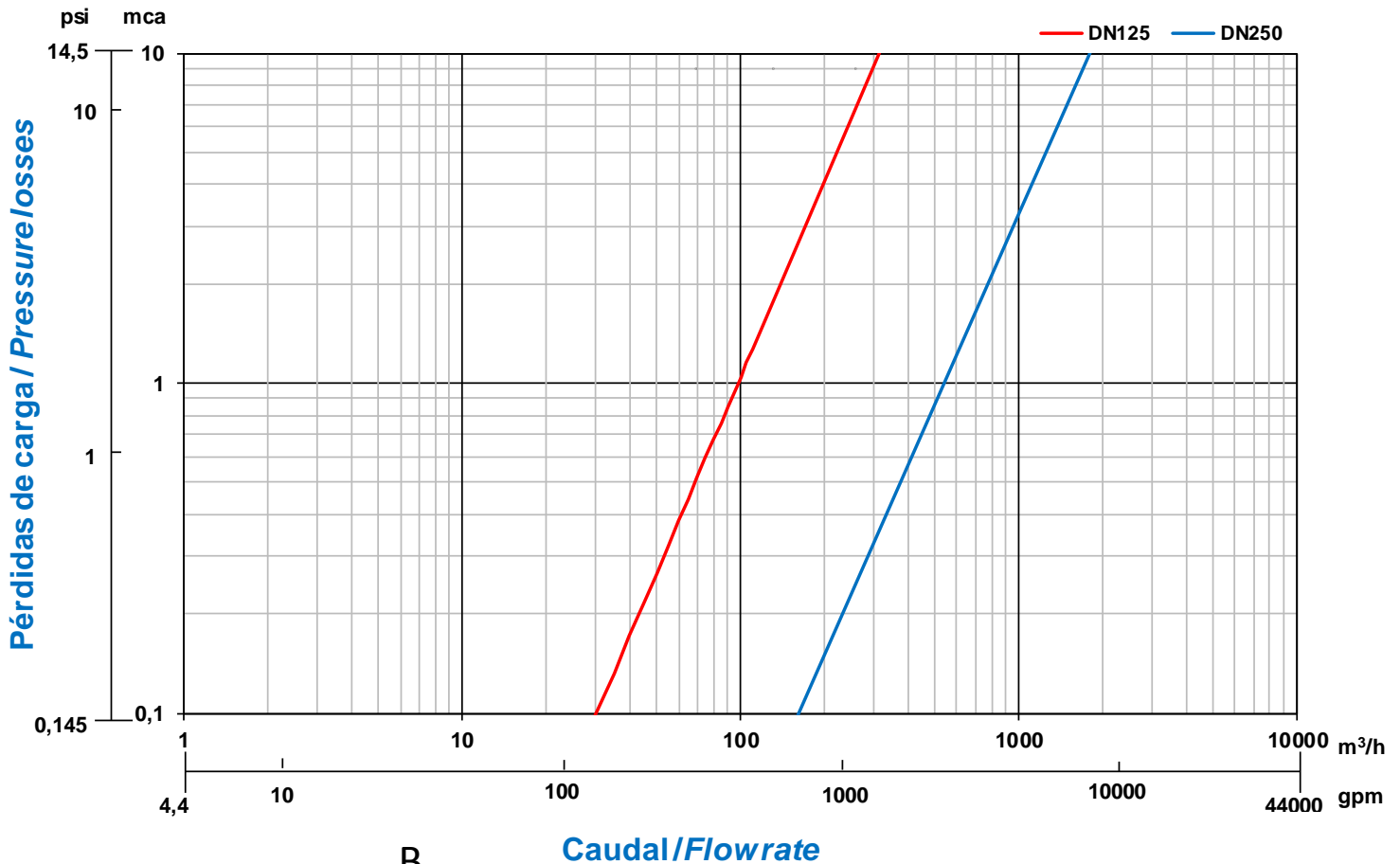

Friction Head Loss is measured from A to B

COMETAL hydraulic valves comply with the specifications of the standards UNE-EN 1267 and ISO 9644 in terms of friction head loss tests.

MODEL	CONNECTION	KV		CONTROL CHAMBER VOLUME
		m3/h	gpm	litres
DN125	FLANGED	315	1386.9	1,40
DN250	FLANGED	1810	7969.2	9,10